

--

Datum:
Kund:
Projekt:



4800

Elektronisk inbyggnads tappventil för varmt eller kallt vatten. Elektronikbox VR2617 ingår.

Flöde

	Bar:	1,0	2,0	3,0	4,0	5,0
4800	(l/min)	14,4	20,4	25,0	28,9	32,3

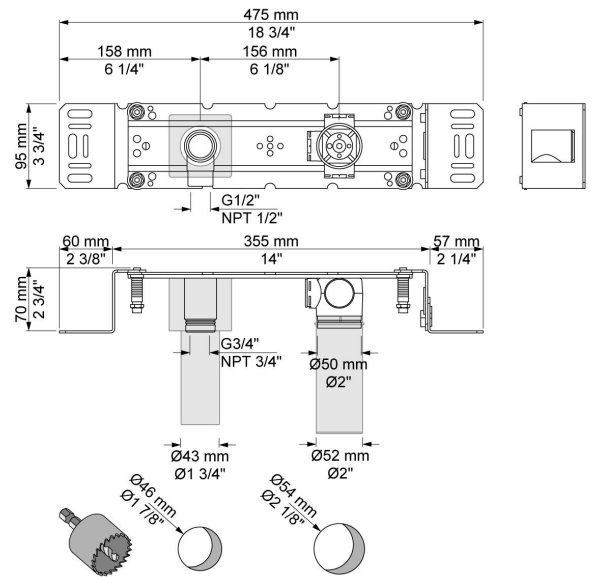

Levereras i färg



VR2617
Elektronikbox.

